

POWERFLOW™ CARTRIDGE

310/400 ML CARTRIDGES DISPENSER



FEATURES

- High quality epoxy coated cast aluminum handle
- U-opening steel frame
- Curved rod end
- Switchable Pressure Relief Device (PRD)
- Rotating Frame
- Spike (US only)

BENEFITS

- Powerful and highly durable
- For ease of cartridge insertion and removal
- Creates convenient tool support and storage
- Prevents material run-on
- For easy cartridge insertion and allows continuous bead around corners
- For piercing barrier in cartridges

APPLICATIONS

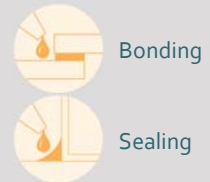

PRODUCT BY RANGE

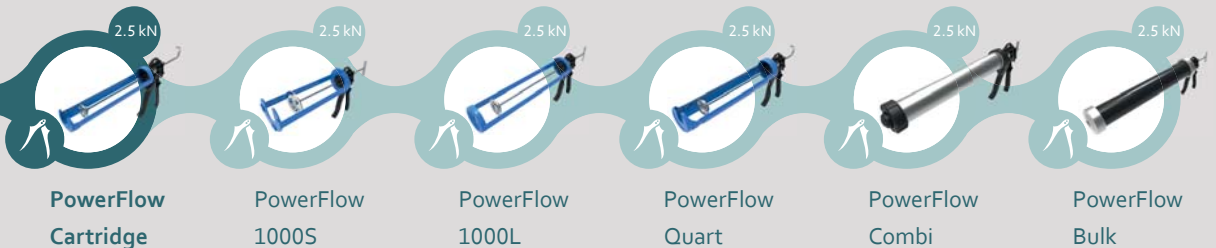

THE POWERFLOW CARTRIDGE 1-COMPONENT MANUAL DISPENSER IS PART OF A RANGE OF HIGH POWERED DISPENSERS DESIGNED FOR USE WITH LOW TO MEDIUM VISCOSITY SEALANTS AND ADHESIVES.

SPECIFICATIONS

- Weight: 0.75–0.79 kg / 1.65–1.74 lbs
- Frame Length: 233–274 mm / 9.3–15.0 in
- Maximum Thrust: 2.5 kN
- Pressure Relief Device (PRD)
- Handle Material: Epoxy Coated Aluminum
- Frame Material: Epoxy Coated Steel
- Cartridge Capacity: 310 mL (10.5 oz), 400 mL (13.5 oz)
- Mechanical Advantage Ratio: (12:1)
- Standard Color: Blue/Black
- Nozzle Dimension: \varnothing 27–31 mm / 1.1–1.2 in
- Customized versions on demand

DIMENSIONS (MM/IN)

product	height (h)	length (l)	depth (d)	frame (f)
Cartridge 310	213 / 8.4	334 / 13.1	58.5 / 2.3	233 / 9.3
Cartridge 400	213 / 8.4	391 / 15.3	58.3 / 2.3	274 / 10.8

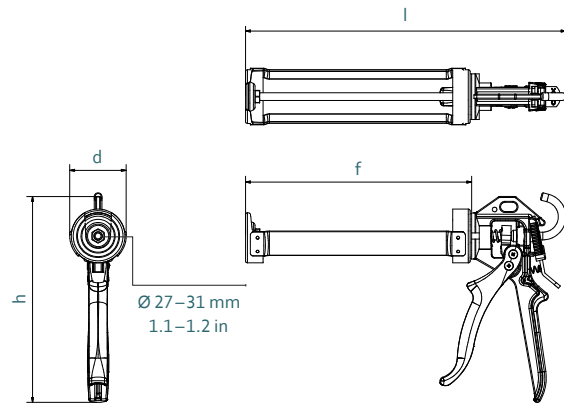

Product	Article number	Packaging
DM1C 310-ca-r12-101	177168 (41004 for US)	10 per Box (6 per Box for US)
DM1C 400-ca-r12-001	177180	10 per Box

MATCHING MIXPAC™ CARTRIDGES



Peeler Cartridge

COMPATIBLE CARTRIDGES

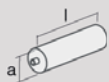

Plastic Cartridge
150 mL HPDE

	mm	inch
l	124.5	4.9
a	\varnothing 48.7	\varnothing 1.9

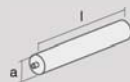

Plastic Cartridge
310 mL HPDE/PP/PA

	mm	inch
l	216.0	8.5
a	\varnothing 48.2	\varnothing 1.8

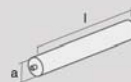

Plastic Cartridge
400 mL HPDE/PA

	mm	inch
l	256.0	10.1
a	\varnothing 49.0	\varnothing 1.9

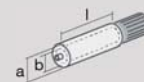

Plastic Cartridge
150 mL 1:1, 2:1, 10:1 PP

	mm	inch
l	117	4.6
a	\varnothing 50.0	\varnothing 1.9
1:1 b	\varnothing 32.0	\varnothing 1.2
2:1 b	\varnothing 26.0	\varnothing 1.0
10:1 b	\varnothing 14.3	\varnothing 0.5

CONVERSION KITS

–

MATCHING ACCESSORIES

Nozzle extension / Twisty nozzle on pages 98–102.