

AIRFLOW™ 2 COMBI

310–600 ML CARTRIDGE & SACHET DISPENSER



Model shown: AirFlow 2 Combi 310 mL

FEATURES

- Glass filled nylon handle
- Integrated handle
- 6.8 bar (100 psi) regulator
- Quick exhaust valve
- Rod driven plunger

BENEFITS

- Ergonomically designed for comfort
- Quick adjustment of pressure regulator
- Fitted as standard – others are available
- Minimizes flow-on
- For precise control and smooth material flow

APPLICATIONS

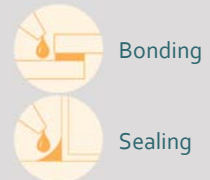

PRODUCT BY RANGE



THE AIRFLOW 2 COMBI 1-COMPONENT PNEUMATIC DISPENSER COMES WITH A GLASS FILLED NYLON HANDLE FOR ADDED COMFORT AND QUICK EXHAUST VALVE MINIMIZING MATERIAL WASTE.

SPECIFICATIONS

- Weight: 1.3–1.64 kg / 2.8–3.6 lbs
- Frame Length: 211–357 mm / 8.3–14.1 in
- Maximum Thrust: 1.45 kN
- Maximum Pneumatic Pressure: 6.8 bar (100 psi)
- Handle Material: Glass Filled Nylon
- Barrel Material: Anodized Aluminum
- Cartridge Capacity: 310 mL (10.5 oz), 400 mL (13.5 oz)
- Sachet Capacity: 310 mL (10.5 oz), 400 mL (13.5 oz), 600 mL (20.3 oz)
- Standard Color: Black/Grey
- Nozzle Dimension: Ø 38 mm / 1.5 in
- Customized versions on demand

DIMENSIONS (MM/IN)

product	height (h)	length (l)	depth (d)	barrel (b)
Combi 310	242 / 9.5	557 / 21.9	69 / 2.7	211 / 8.3
Combi 400	242 / 9.5	633 / 24.9	69 / 2.7	249 / 9.8
Combi 600	242 / 9.5	849 / 33.4	69 / 2.7	357 / 14.1

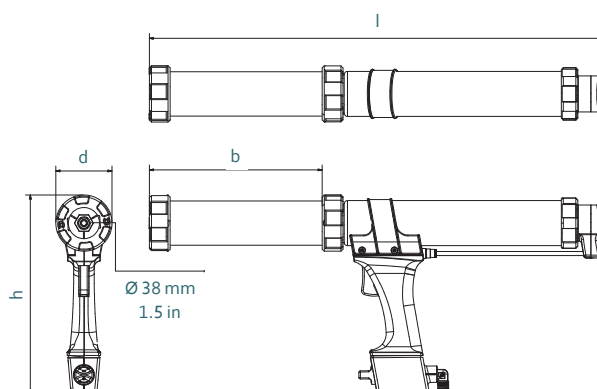

Product	Article number	Packaging
DP1C 310-cm-145-201	178234 (61004-LP for US)	10 per Box (1 per Box for US)
DP1C 400-cm-145-201	178240	10 per Box
DP1C 600-cm-145-201	178242	10 per Box

MATCHING MIXPAC™ CARTRIDGES



Peeler Cartridge

COMPATIBLE CARTRIDGES AND SACHETS

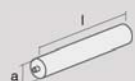

Plastic Cartridge
310 mL HPDE/PP/PA

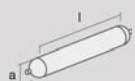

Sachet
310 mL

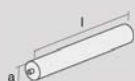

Plastic Cartridge
400 mL HPDE/PA

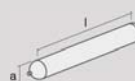

Sachet
400 mL

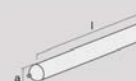

Sachet
600 mL

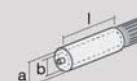

Plastic Cartridge
150 mL 1:1, 2:1, 10:1 PP

	mm	inch	mm	inch	mm	inch	mm	inch	mm	inch	mm	inch	
l	216.0	8.5	220.0	8.66	256.0	10.1	258.0	10.16	335.0	13.2	117	4.6	
a	Ø 48.2	Ø 1.8	Ø 50.0	Ø 1.97	Ø 49.0	Ø 1.9	Ø 50.0	Ø 1.97	Ø 50.0	Ø 2.0	Ø 50.0	Ø 1.9	
											1:1 b	Ø 32.0	Ø 1.2
											2:1 b	Ø 26.0	Ø 1.0
											10:1 b	Ø 14.3	Ø 0.5

CONVERSION KITS

Peeler Front Cap

MATCHING ACCESSORIES

On pages 98–102.